

# Incremental encoders

Resolution 1...2048 pulses



## FNC 40V Series



### Features

- Industry 40 mm standard size, screw flange
- Robust mechanical and electrical construction
- Protection up to IP65
- Up to 2048 ppr max.
- <300 kHz frequency
- Optical and magnetic sensing

### Technical data-electrical ratings

Voltage supply	4.75VDC to 30VDC 4.75VDC to 5.5VDC
Protection	Output short circuit protection. Reverse polarity protection (except 5V version)
Consumption w/o load	≤60 mA (24 VDC)
Resolution (steps/turn)	1...2048 ppr
Reference signal	Zero pulse, width 90° 180°, 360° optional
Optoelectronic life time	100.000 (min)
Output frequency	>300 kHz
Output signals	90° shifted A and B, Z+ inverted
Output circuit	Linedriver / RS422 Push-pull short-circuit proof NPN Open Collector
Interference immunity	DIN EN 61000-6-2
Emitted interference	DIN EN 61000-6-4
Approval	CE

### Technical data-mechanical ratings

Dimensions (flange)	Ø40 mm
Shaft loading	≤60 N axial ≤80 N radial
Protection DIN EN 60529	IP54, IP65
Operating speed	≤10.000 rpm
Starting torque	≤0.020 Nm (IP67)
Materials	Housing: aluminum Flange: aluminum Shaft: stainless steel
Shaft diameter	4, 5, 6, 8 mm (other diameters on request)
Bearings lifetime	2x10 <sup>9</sup> rev. at 100% of full rated shaft load (minimum)
Operating temperature	-20...+85°C
Storage temperature	-30°C up to +90°C
Weight approx.	150 g

#### Mechanical Dimensions

**V1: M20 Version**

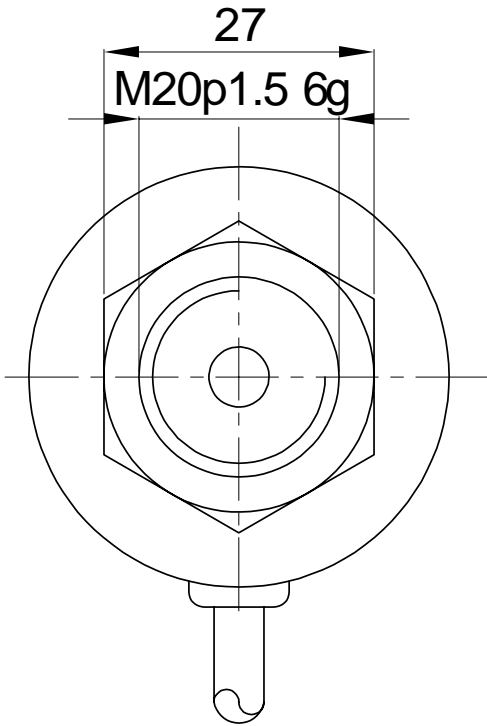

**V2: M24 Version**

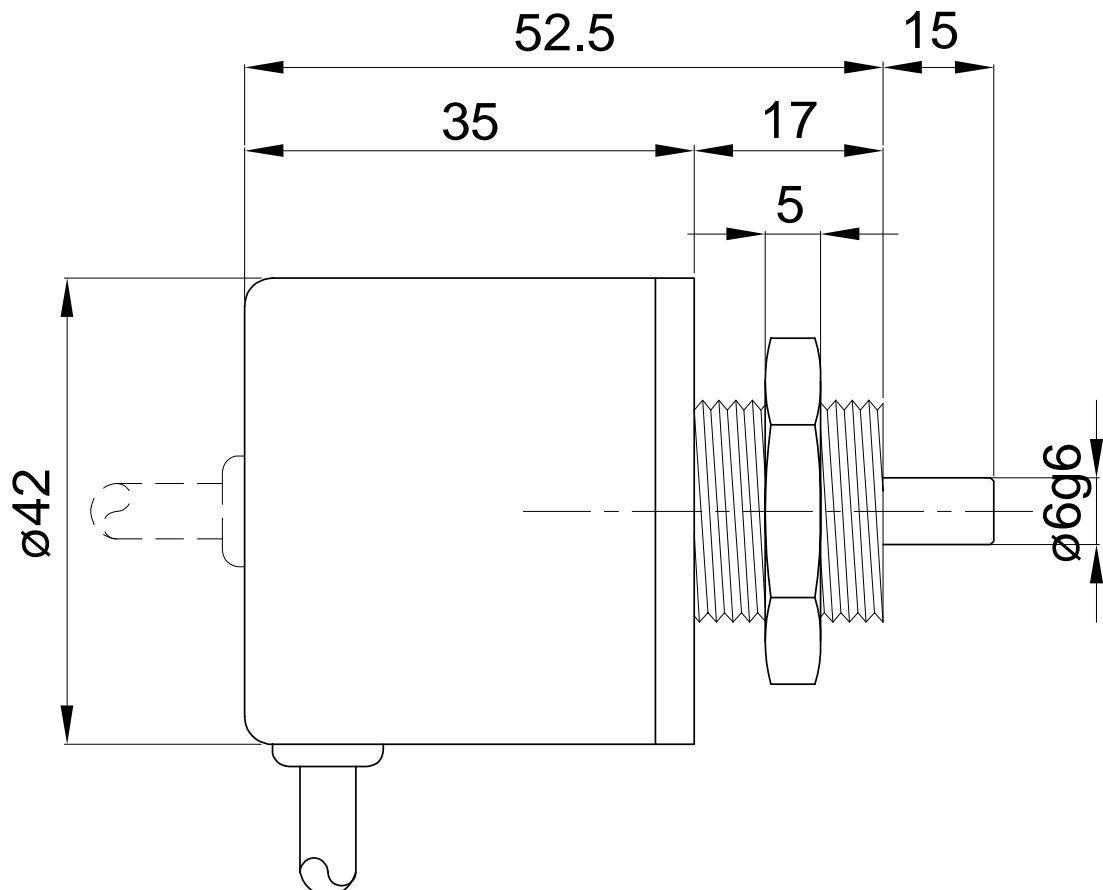
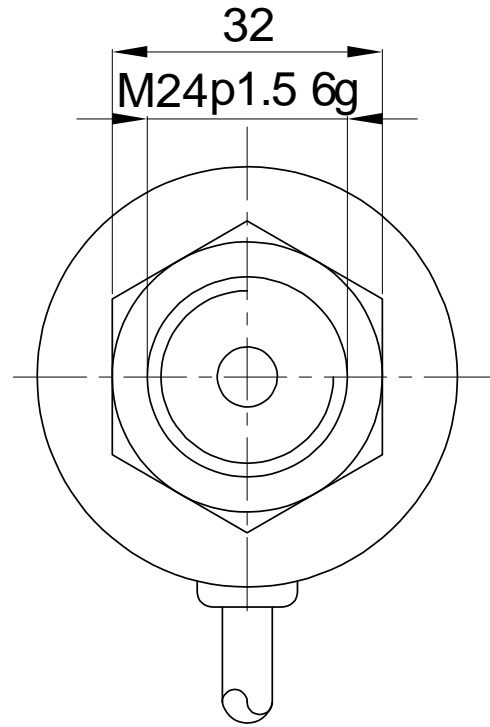









# Incremental encoders

Cable / Connector Wiring, Part Number









## FNC 40V Series

### Cable Connection

	Color	Renk	Farbe	Цвет	颜色
+VB	 Brown	Kahve	Braun	Коричневый	棕色的
GND	 White	Beyaz	Weiß	Белый	白色的
A	 Green	Yeşil	Grün	Зеленый	绿
A'	 Red	Kırmızı	Rot	Красный	红色的
B	 Yellow	Sarı	Gelb	Желтый	黄色的
B'	 Pink	Pembe	Rosa	Розовый	粉色的
Z	 Gray	Gri	Grau	Серый	灰色的
Z'	 Blue	Mavi	Blau	Синий	蓝色的
Shield	Black	Siyah	Schwarz	Черный	黑色的

### Connector Connection

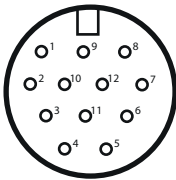
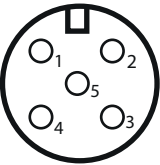
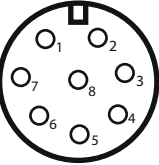
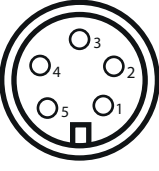
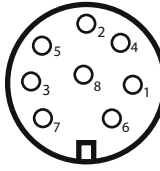
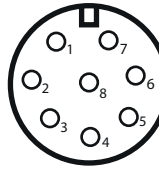
Function	R2312R	R1205	R1208	R1505	R1508	R1608
+VB	pin 2-12	pin 1	pin 1	pin 1	pin 1	pin 1
GND	pin 10-11	pin 2	pin 2	pin 2	pin 2	pin 2
A	pin 5	pin 3	pin 3	pin 3	pin 3	pin 3
A'	pin 6		pin 4		pin 4	pin 4
B	pin 8	pin 4	pin 5	pin 4	pin 5	pin 5
B'	pin 1		pin 6		pin 6	pin 6
Z	pin 3	pin 5	pin 7	pin 5	pin 7	pin 7
Z'	pin 4		pin 8		pin 8	pin 8
Connector						
Pin Design						

\*\* for other connector options visit [www.fenac.com.tr](http://www.fenac.com.tr)

# Incremental encoders

## Pulse Diagram, Part Number

### FNC 40V Series

#### Pulse Diagram

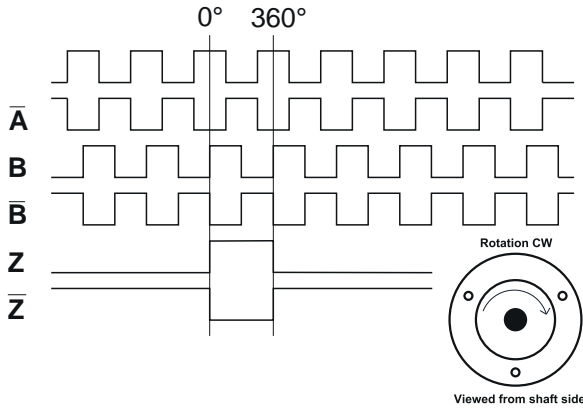

#### Encoder Part Number

