

Incremental encoders

Resolution 1...2.000.000 pulses



FNC 50B Series



Features

- Industry 50 mm standard size, clamping flange
- Robust mechanical and electrical construction
- Protection up to IP67
- Up to 2.000.000 ppr max.
- <300 kHz frequency
- Optical and magnetic sensing

Technical data-electrical ratings

Voltage supply	4.75VDC to 30VDC 4.75VDC to 5.5VDC
Protection	Output short circuit protection. Reverse polarity protection (except 5V version)
Consumption w/o load	≤60 mA (24 VDC)
Resolution (steps/turn)	1...2.000.000 ppr
Reference signal	Zero pulse, width 90° 180°, 360° optional
Optoelectronic life time	100.000 (min)
Output frequency	>200 kHz
Output signals	90° shifted A and B, Z+ inverted
Output circuit	Linedriver / RS422 Push-pull short-circuit proof NPN Open Collector
Interference immunity	DIN EN 61000-6-2
Emitted interference	DIN EN 61000-6-4
Approval	CE

Technical data-mechanical ratings

Dimensions (flange)	Ø50 mm
Shaft loading	≤60 N axial ≤80 N radial
Protection DIN EN 60529	IP54, IP65
Operating speed	≤10.000 rpm
Starting torque	≤0.025 Nm (IP67)
Materials	Housing: aluminum Flange: aluminum Shaft: stainless steel
Shaft diameter	5, 6, 7, 8, 10, 12 mm (other diameters on request)
Bearings lifetime	2x10 ⁹ rev. at 100% of full rated shaft load (minimum)
Operating temperature	-20...+85°C
Storage temperature	-30°C up to +90°C
Weight approx.	150 g

FNC 50B Series

Mechanical Dimensions

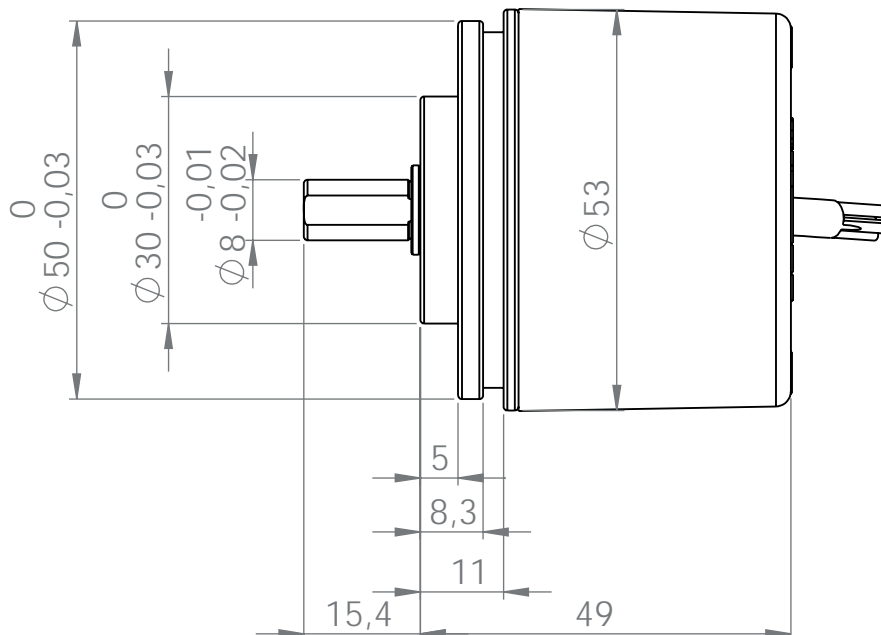
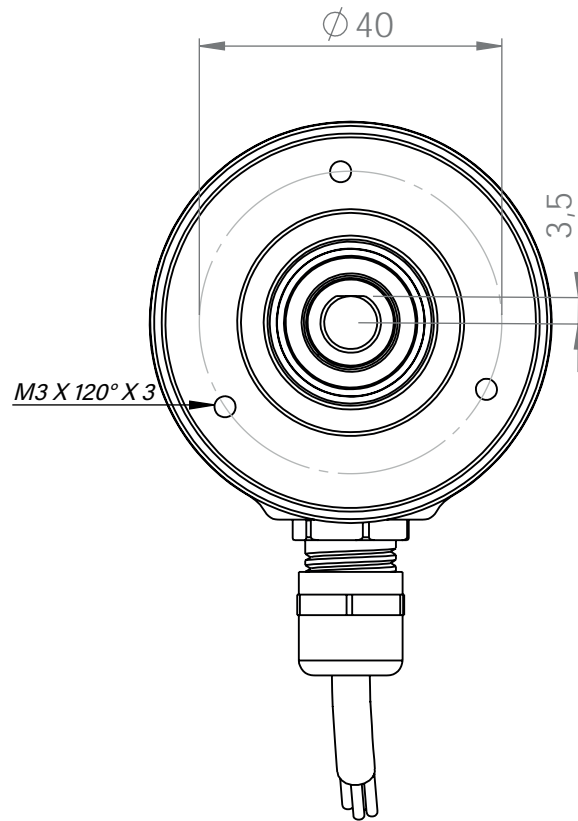









Incremental encoders

Cable / Connector Wiring, Part Number









FNC 50B Series

Cable Connection

Function	Color	Renk	Farbe	Цвет	颜色
+VB	 Brown	Kahve	Braun	Коричневый	棕色的
GND	 White	Beyaz	Weiß	Белый	白色的
A	 Green	Yeşil	Grün	Зеленый	绿
A'	 Red	Kırmızı	Rot	Красный	红色的
B	 Yellow	Sarı	Gelb	Желтый	黄色的
B'	 Pink	Pembe	Rosa	Розовый	粉色的
Z	 Gray	Gri	Grau	Серый	灰色的
Z'	 Blue	Mavi	Blau	Синий	蓝色的
Shield	Black	Siyah	Schwarz	Чернить	黑色的

Connector Connection

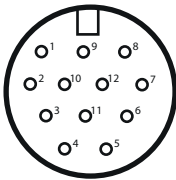
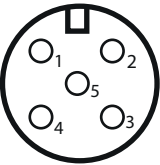
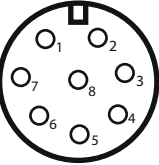
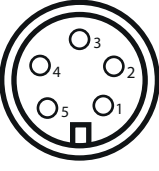
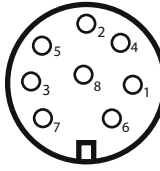
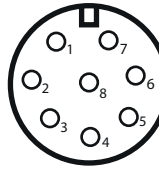
Function	R2312R	R1205	R1208	R1505	R1508	R1608
+VB	pin 2-12	pin 1	pin 1	pin 1	pin 1	pin 1
GND	pin 10-11	pin 2	pin 2	pin 2	pin 2	pin 2
A	pin 5	pin 3	pin 3	pin 3	pin 3	pin 3
A'	pin 6		pin 4		pin 4	pin 4
B	pin 8	pin 4	pin 5	pin 4	pin 5	pin 5
B'	pin 1		pin 6		pin 6	pin 6
Z	pin 3	pin 5	pin 7	pin 5	pin 7	pin 7
Z'	pin 4		pin 8		pin 8	pin 8
Connector						
Pin Design						

** for other connector options visit www.fenac.com.tr

Incremental encoders

Pulse Diagram, Part Number

FNC 50B Series

Pulse Diagram

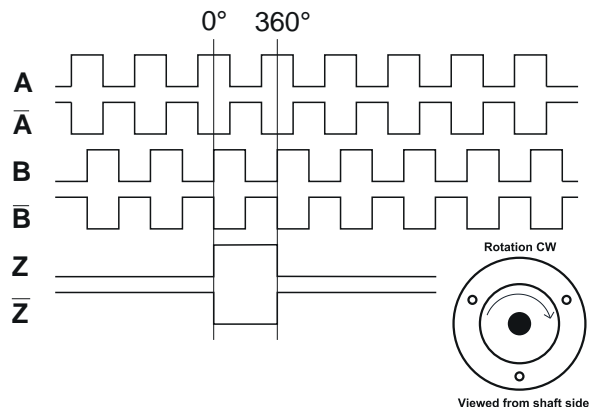

Encoder Part Number

