

Incremental encoders

Resolution 1...65.536 pulses



FNC 58H SS Series



Features

- Industry 58 mm standard size, end hollow shaft
- Robust mechanical and electrical construction
- Protection up to IP67
- Up to 65.536 PPR max.
- <300 kHz frequency

Technical data - electrical ratings

Voltage supply	4.75VDC to 30VDC 4.75VDC to 5.5VDC
Protection:	Output short circuit protection. Reverse polarity protection (except 5V version)
Consumption w/o load	≤60 mA (24 VDC)
Resolution (steps/turn)	up to 65536
Reference signal	Zero pulse, width 90° 180°, 360° optional
Optoelectronic life time	100.000 (min)
Output frequency	>200 kHz
Output signals	90° shifted A and B, Z + inverted
Output circuit	Linedriver/RS422 Push-pull short-circuit proof NPN Open Collector
Interference immunity	DIN EN 61000-6-2
Emitted interference	DIN EN 61000-6-4
Approval	CE

Technical data - mechanical design

Dimensions (flange)	ø58 mm
Shaft loading	≤120 N axial ≤160 N radial
Protection DIN EN 60529	IP54, IP65
Operating speed	≤10000 rpm
Starting torque	≤0.025 Nm (IP 67)
Materials	Housing : Stainless Steel Shaft: Stainless Steel Flange: Stainless Steel Spring: Stainless Steel Clamping Ring: Stainless Steel Cable Gland: Stainless Steel
Shaft diameter:	6, 8, 10, 12, 14, 15, 16 mm
Bearings lifetime:	2x10 ⁹ rev. at 100% of full rated shaft load (minimum)
Operating temperature	-20...+85 °C
Storage temperature	-30 °C up to +90 °C
Weight approx.	250 g

Pulse Diagram

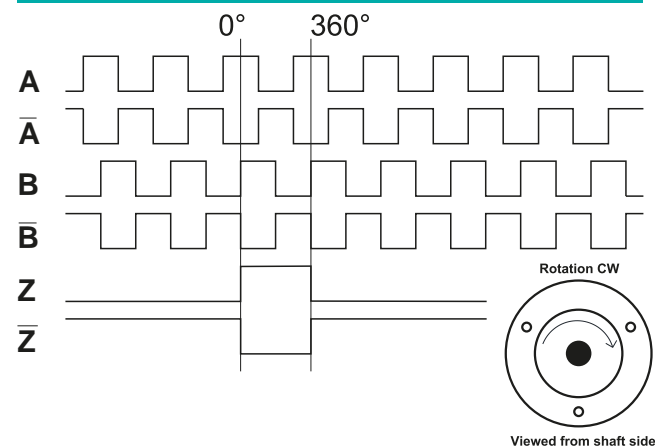

FNC 58H SS Series

Mechanical Dimensions

58H

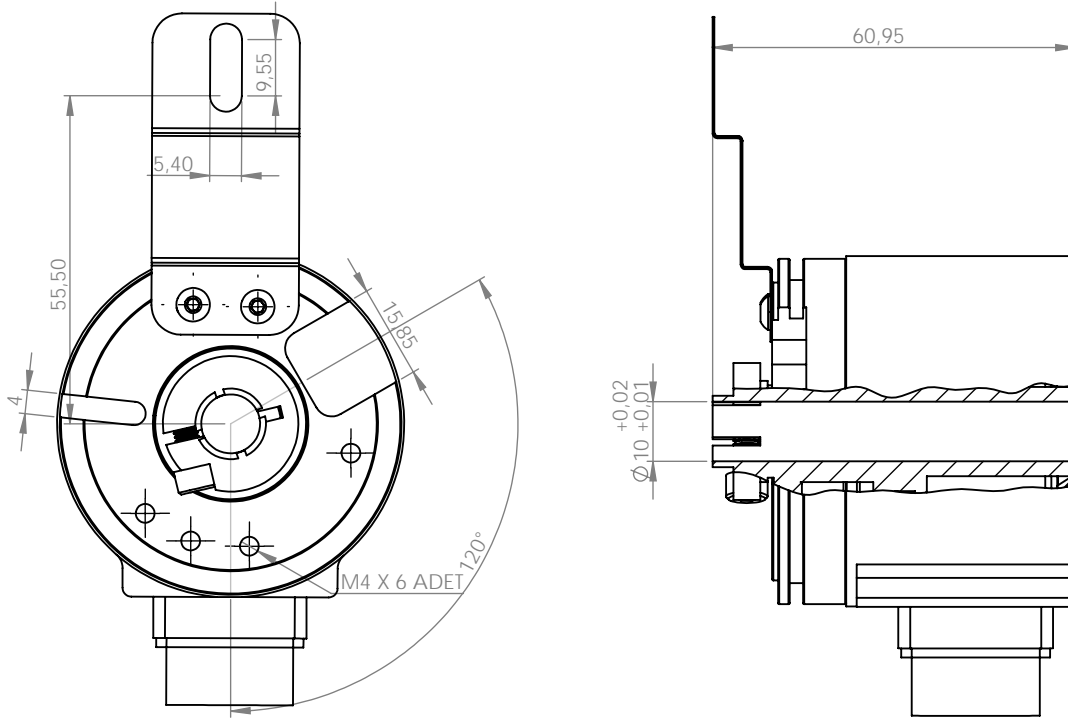

58H BB

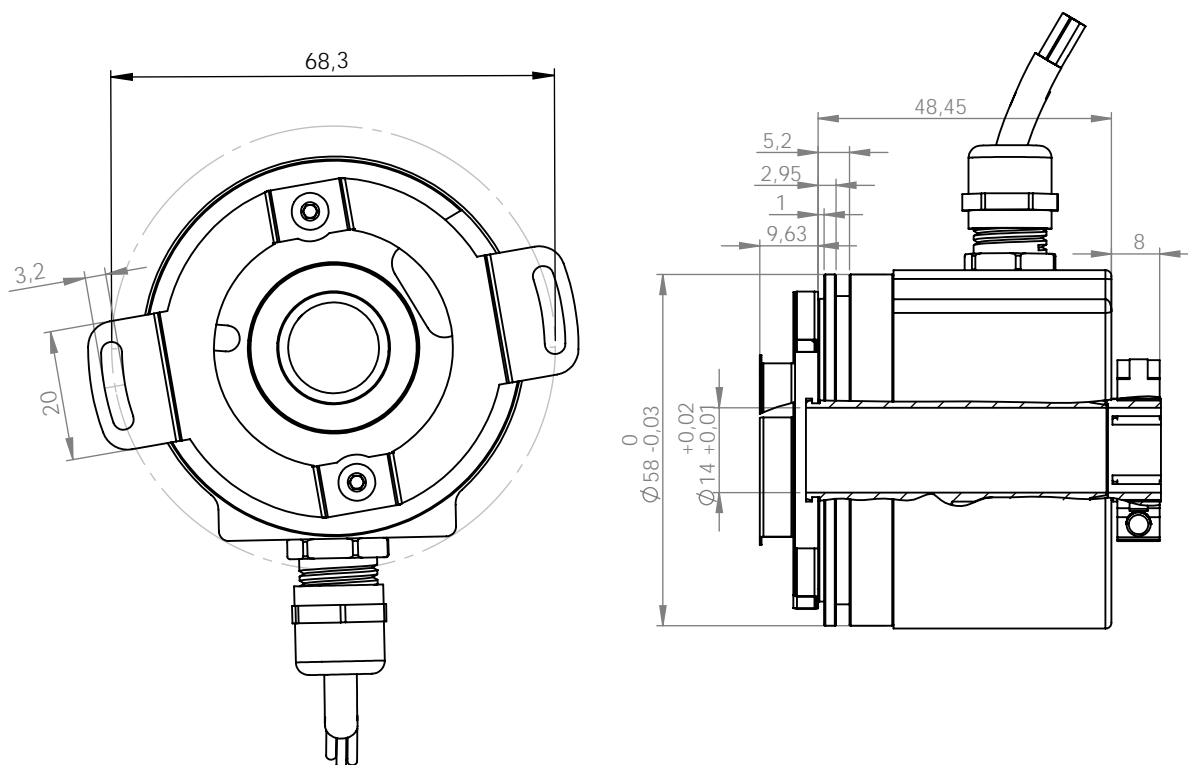





Incremental encoders

Cable/Connector Wiring



FNC 58H SS Series

Cable / Connector Wiring

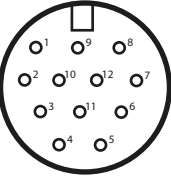
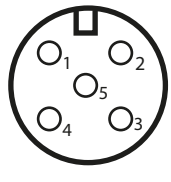
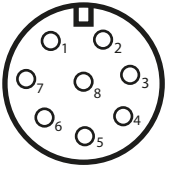
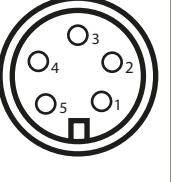
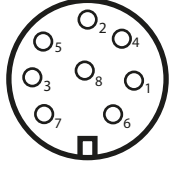
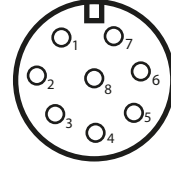
Function	R2312R	R1205	R1208	R1505	R1508	R1608
+VB	pin 2-12	pin 1	pin 1	pin 1	pin 1	pin 1
GND	pin 10-11	pin 2	pin 2	pin 2	pin 2	pin 2
A	pin 5	pin 3	pin 3	pin 3	pin 3	pin 3
A'	pin 6		pin 4		pin 4	pin 4
B	pin 8	pin 4	pin 5	pin 4	pin 5	pin 5
B'	pin 1		pin 6		pin 6	pin 6
Z	pin 3	pin 5	pin 7	pin 5	pin 7	pin 7
Z'	pin 4		pin 8		pin 8	pin 8
Connector						
Pin Design						

** for other connector options visit www.fenac.com.tr

Cable Wiring

Function	Color	Renk	Farbe	Цвет	颜色
+VB	 Brown	Kahve	Braun	Коричневый	棕色的
GND	 White	Beyaz	Wei	Белый	白色的
A	 Green	Yeil	Grn	Зеленый	绿
A'	 Red	Kırmızı	Rot	Красный	红色的
B	 Yellow	Sarı	Gelb	Желтый	黄色的
B'	 Pink	Pembe	Rosa	Розовый	粉色的
Z	 Gray	Gri	Grau	Серый	灰色的
Z'	 Blue	Mavi	Blau	Синий	蓝色的
Shield	Black	Siyah	Schwarz	Чернить	黑色的

FNC 58H SS Series

Encoder Part Number

