

Absolute encoders - SSI / BiSS + SinCos

Internal bearing for integration in motors



FNC ASS 58S Series



Features

- Encoder single SSI/BiSS + SinCos
- Optical sensing
- Resolution 13 bit standard, programmable
- 2048 SinCos signal
- Servo flange
- Permanent check of code continuity
- Extreme resistance to shock and vibration
- Encoder with electronic reset

Technical data-electrical ratings

Voltage supply	5.5VDC to 30VDC 4.75VDC to 5.5VDC
Protection	Output short circuit protection. Reverse polarity protection (except 5V version)
Consumption w/o load	≤50 mA (24 VDC)
Interface	SSI or BiSS
Resolution (steps/turn)	Optic : 19 bit
Absolute accuracy	Optic : ± 0.025°
Optoelectronic life time	100,000 (min)
Code	Gray or Binary
Inputs	SSI differential clock Direction Electronic zero setting Chip select (optional)
Output frequency	up to 2 MHz (SSI) up to 10 MHz (BiSS)
Output circuit	SSI data linedriver RS485 2048 Sin/Cos signals
Interference immunity	DIN EN 61000-6-2
Emitted interference	DIN EN 61000-6-4
Approval	CE

Technical data-mechanical ratings

Dimensions (flange)	Ø58 mm
Shaft loading	≤140 N axial ≤240 N radial
Protection DIN EN 60529	IP54, IP65
Operating speed	≤10,000 rpm
Starting torque	≤0.025 Nm (IP67)
Materials	Housing: aluminum Shaft: stainless steel
Shaft diameter	6, 8, 10, 12 mm (other diameters on request)
Bearings lifetime	2x10 ⁹ rev. at 100% of full rated shaft load (minimum)
Operating temperature	-40...+110°C
Storage temperature	-40°C up to +120°C
Weight approx.	350 g

Absolute encoders - SSI / BiSS + SinCos







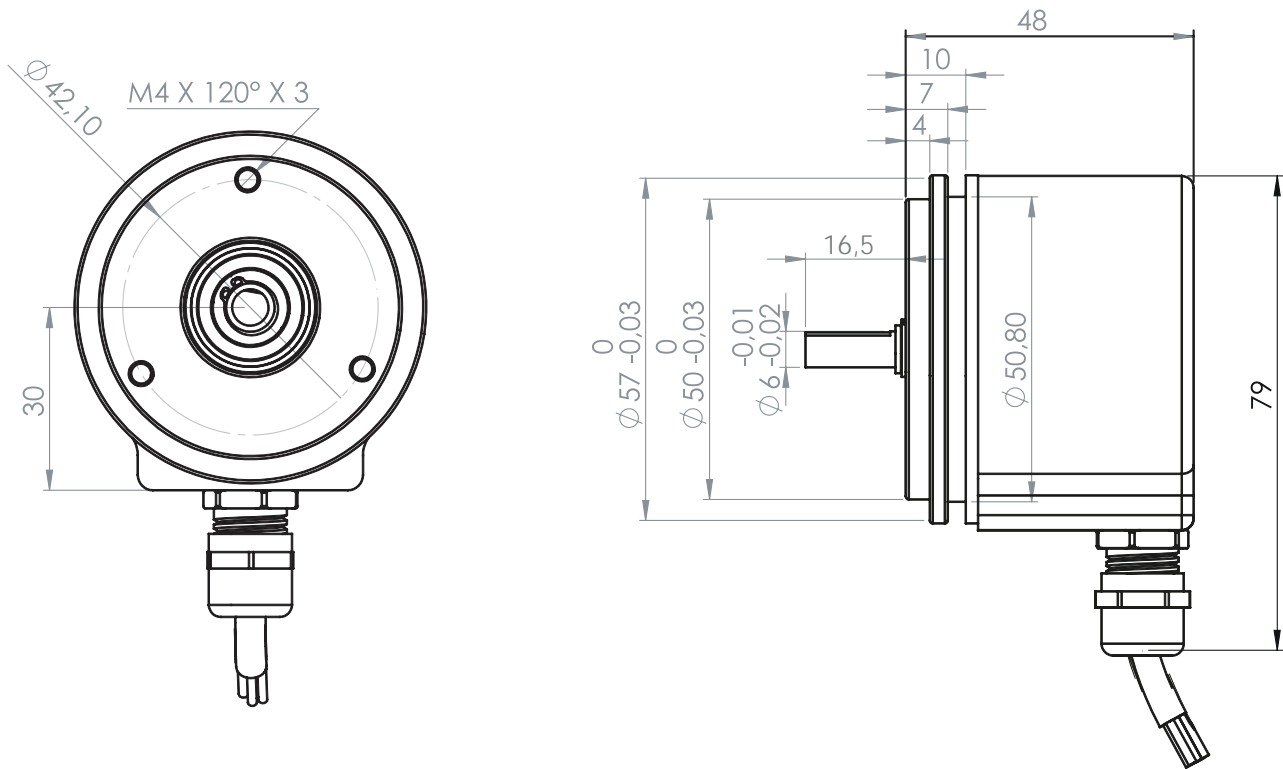

Mechanical Dimensions
Cable / Connector Wiring

FNC ASS 58S Series

Mechanical Dimensions



Cable Connection

Function	Color	Renk	Farbe	Цвет
+VB	 Brown	Kahve	Braun	Коричневый
GND	 White	Beyaz	Wei	Белый
DATA+	 Orange	Turuncu	Orange	Оранжевый
DATA-	 Orange-Black	Turuncu-Siyah	Orange-Schwarz	Оранжево-черный
CLOCK+	 Blue	Mavi	Gelb	синий
CLOCK-	 Blue-Black	Mavi-Siyah	Gelb-Schwarz	сине-черный
PRESET	 Gray	Gri	Grau	Серый
DIRECTION	 Gray-Black	Gri-Siyah	Grau-Schwarz	Серо-черный
Shield	Black	Siyah	Schwarz	Чернить

Absolute encoders - SSI / BiSS + SinCos

Cable / Connector Wiring, Part Number



FNC ASS 58S Series

2048 SinCos Pulse Diagram

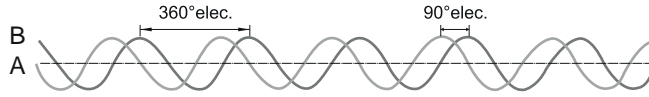

Signals shown at CW rotation with view on shaft's end

SSI - BiSS Pulse Diagram

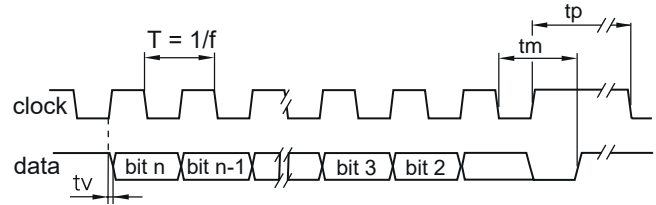

Clock frequency, f	50...2000 kHz for SSI up to 10 MHz for BiSS
Code	Binary or Gray
Status and parity bit	On request
Monoflop time t_m	>15 μ s
Clock time out	Programmable at factory

Terminal Significance

+Vs	Encoder supply voltage
0 V	Encoder ground connection relating to +Vs
Data+	Positive data output.
Data-	Negative data output.
Clock+	Positive SSI clock output.
Clock-	Negative SSI clock output.
Zero	Input for setting a zero point anywhere within the encoder resolution. The zero setting operation is triggered with Vs.
Direction	UP/DOWN counting direction input. This input is standard on High. UP/DOWN means ascending output data with clockwise shaft rotation when looking at flange.
Preset	Parameter for setting the encoder to a requested position value assigned to a defined shaft position of the system. The offset of zero encoder zero point and mechanical zero point is stored in the encoder

Encoder Part Number

